

SERIES D16, P16, L16 SWITCHES

PUSHBUTTON SWITCHES - ILLUMINATED

TACT SWITCHES

NAVIGATION SWITCHES

PUSHBUTTON SWITCHES

TOGGLE SWITCHES

ROCKER SWITCHES

SLIDE SWITCHES

SNAP-ACTION SWITCHES

DIP SWITCHES

KEYLOCK SWITCHES

ROTARY SWITCHES

DETECTOR SWITCHES

CAP OPTIONS



SPECIFICATIONS

| | |
|-------------------------------|---|
| Contact Rating: | 5A@250 VAC-UL, VDE 8A@125 VAC - UL, CSA 6A@24 VDC - UL, CSA |
| Life Expectancy (Mechanical): | 100,000 cycles |
| Life Expectancy (Electrical): | 50,000 cycles |
| Contact Resistance: | 100mΩ max. typical; initial @ 2-4 VDC |
| Insulation Resistance: | > 1,000MΩ |
| Dielectric Strength: | > 1,500 volts 1 minute > 3,000 volts between poles |
| Actuation Force: | 300g/pole |
| Operating Temperature: | -20°C to 55°C |

FEATURES & BENEFITS

- ▶ Modular interface/contact block design
- ▶ Robust product for industrial applications
- ▶ Attractive front panel design
- ▶ Illuminated options available

APPLICATIONS/MARKETS

- ▶ Industrial controls
- ▶ Instrumentation
- ▶ Transportation
- ▶ Telecommunications

MATERIALS

| | |
|------------------|----------------------------|
| Switch Housing: | Polyetherimide (PEI) |
| Contact Housing: | Diallyl Phthalate (DAP) |
| Lens: | Polycarbonate (PC) |
| Contacts: | Silver plated copper alloy |
| Terminals: | Silver plated copper alloy |

HOW TO ORDER

| SERIES | MECHANICAL CONFIGURATION | PUSHBUTTON HEAD | CIRCUIT | LAMP TYPE & VOLTAGE | LAMP COLOR (WHERE APPLICABLE) | LENS COLOR |
|---|--|--|--|---|--|------------|
| D16 = Solder Lug P16 = Socket L16 = Pilot Indicator | EE = Latching OA = Momentary PL* = Pilot Indicator *For L16 (Pilot Indicator) | S1 S2 T1 T2 R* R1 *R (Mushroom Head) Available for D16 & P16 Only. | 0* = Pilot Ind. 1**= SPDT 2 = DPDT 3 = 3PDT 4 = 4PDT *For L16 only (Pilot Indicator) **P16 available SPDT only | 0 = None A B C F ----- Red G ----- Grn H ----- Red J ----- Grn K ----- Yel M N L D E | RED= Red GRN= Green BLU= Blue* WHT= White* ORG= Orange* YEL= Yellow* *Not Available For 'R' Mushroom Head. | |

▶ ▶ ▶ **Example Ordering Number**
D16-EE-R1-3-A-BLU

Specifications subject to change without notice.



SERIES D16 SWITCHES

PUSHBUTTON SWITCHES - ILLUMINATED

D16 (SOLDER LUG)

R

MUSHROOM

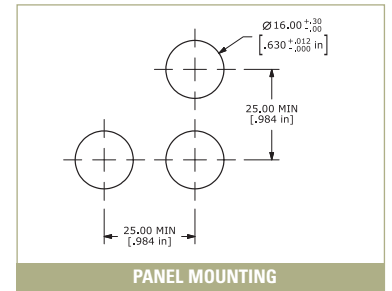

D16 (SOLDER LUG)

R1

ROUND

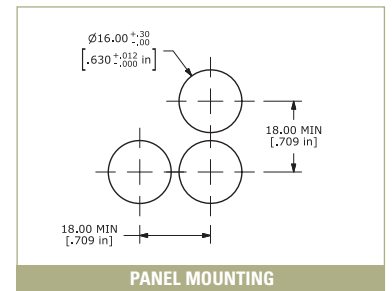

D16 (SOLDER LUG)

S1

SQUARE

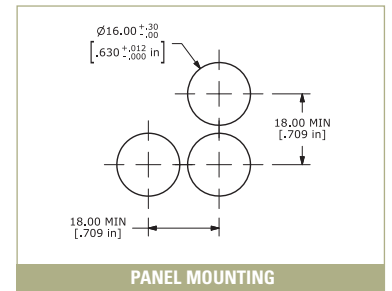
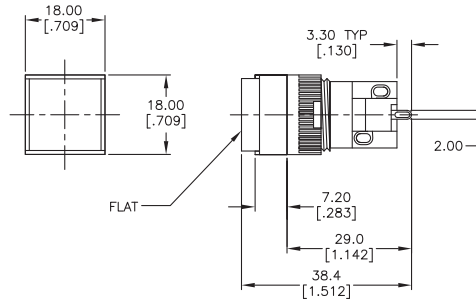

D16 (SOLDER LUG)

T1

RECTANGULAR

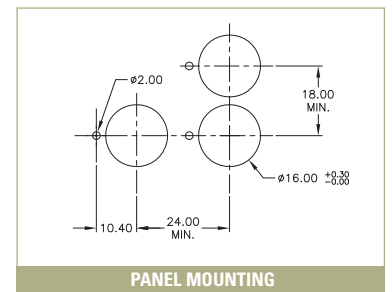
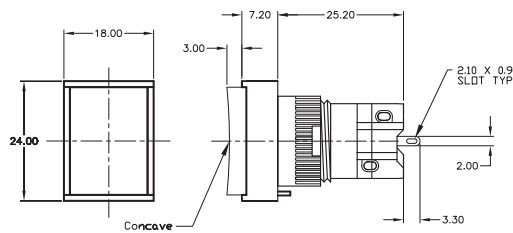

BOTTOM VIEW



SCHEMATIC



MOUNTING LENGTH

| | Mounting Length (A) |
|------|---------------------|
| SPDT | 29.0 mm |
| DPDT | 36.5 mm |
| 3PDT | 44.0 mm |
| 4PDT | 51.5 mm |

SERIES P16 SWITCHES

PUSHBUTTON SWITCHES - ILLUMINATED

TACT SWITCHES

NAVIGATION SWITCHES

PUSHBUTTON SWITCHES

TOGGLE SWITCHES

ROCKER SWITCHES

SLIDE SWITCHES

SNAP-ACTION SWITCHES

DIP SWITCHES

KEYLOCK SWITCHES

ROTARY SWITCHES

DETECTOR SWITCHES

CAP OPTIONS

P16 (SOCKET)

R

MUSHROOM



PANEL MOUNTING

P16 (SOCKET)

R1

ROUND



PANEL MOUNTING

P16 (SOCKET)

S1

SQUARE



PANEL MOUNTING

P16 (SOCKET)

T1

RECTANGULAR



PANEL MOUNTING

BOTTOM VIEW



SCHEMATIC





SERIES L16 SWITCHES

PUSHBUTTON SWITCHES - ILLUMINATED

L16 (PILOT INDICATOR)

R1

ROUND

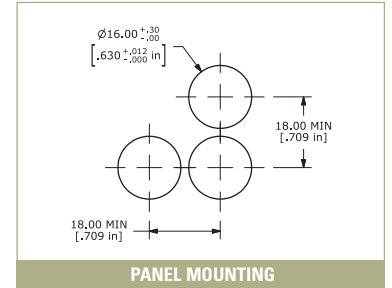
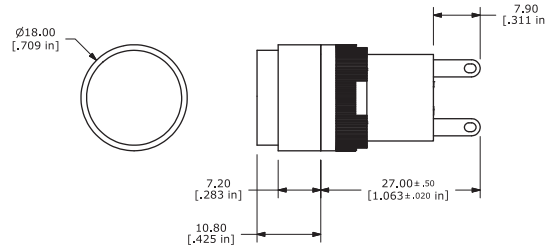

PANEL MOUNTING

L16 (PILOT INDICATOR)

S1

SQUARE

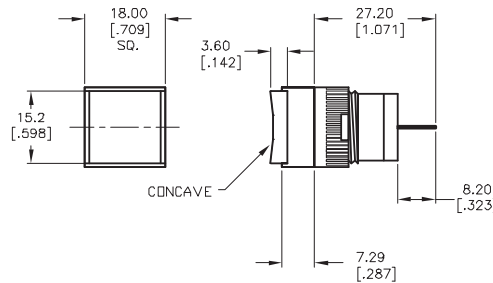

PANEL MOUNTING

L16 (PILOT INDICATOR)

T1

RECTANGULAR



PANEL MOUNTING

BOTTOM VIEW

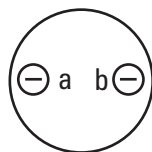

SCHEMATIC



SERIES D16, P16, L16 SWITCHES

PUSHBUTTON SWITCHES - ILLUMINATED

TACT SWITCHES

NAVIGATION SWITCHES

PUSHBUTTON SWITCHES

TOGGLE SWITCHES

ROCKER SWITCHES

SLIDE SWITCHES

SNAP-ACTION SWITCHES

DIP SWITCHES

KEYLOCK SWITCHES

ROTARY SWITCHES

DETECTOR SWITCHES

CAP OPTIONS

MECHANICAL CONFIGURATION & CIRCUIT OPTIONS

0 PILOT INDICATOR

Available 'L16' Pilot Indicator Type



SCHEMATIC

1 SPDT**

Available for 'P16' Socket Type and 'D16' Solder Lug

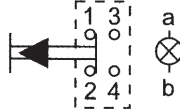

SCHEMATIC

2 DPDT

Available for 'D16' Solder Lug

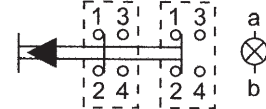

SCHEMATIC

3 3PDT

Available for 'D16' Solder Lug



SCHEMATIC

4 4PDT

Available for 'D16' Solder Lug



SCHEMATIC

Mechanical Configuration Code

| | |
|----|------------------|
| EE | Latching |
| OA | Momentary |
| PL | Pilot Indicator* |

*L16' Series only

LAMP TYPE & VOLTAGE OPTIONS

| ILLUSTRATION | CATEGORY | DESCRIPTION | COLOR | PART NO. |
|--------------------|--------------|---------------------|----------------|-----------|
| | Incandescent | A = 6V AC/DC 200 mA | Not Applicable | 50-004-02 |
| | | B = 14V AC/DC 80 mA | | 50-004-04 |
| | | C = 28V AC/DC 40 mA | | 50-004-05 |
| | | D = 48V AC/DC 25 mA | | 50-004-06 |
| | | E = 60V AC/DC 20 mA | | 50-004-07 |
| | | L = 33V AC/DC 35 mA | | 50-004-08 |
| | | N = 14V AC/DC 40 mA | | 50-004-03 |
| M = 6V AC/DC 40 mA | 50-004-01 | | | |
| | Neon | F = 110V AC | green | 50-004-11 |
| | | | red | 50-004-12 |
| | | G = 220V AC | green | 50-004-13 |
| | | | red | 50-004-14 |
| | LED | H = 6V DC | green | 50-004-16 |
| | | | red | 50-004-17 |
| | | | yellow | 50-004-18 |
| | | J = 12V DC | green | 50-004-19 |
| | | | red | 50-004-20 |
| | | | yellow | 50-004-21 |
| K = 24V DC | green | 50-004-22 | | |
| | red | 50-004-23 | | |
| | yellow | 50-004-24 | | |



| ILLUSTRATION | | STYLE | SHAPE | COLOR | PART NO. |
|---|--|---------------|---------|---|--|
|  | Available Color Lens (Acrylic Resin) | Round | Concave | blue green orange red white yellow | 50-001-01 50-001-02 50-001-03 50-001-04 50-001-05 50-001-06 |
|  | | Rectangular | Concave | blue green orange red white yellow | 50-002-01 50-002-02 50-002-03 50-002-04 50-002-05 50-002-06 |
|  | | Square | Concave | blue green orange red white yellow | 50-003-01 50-003-02 50-003-03 50-003-04 50-003-05 50-003-06 |
|  | | Mushroom Head | Convex | green red | 50-012-01 50-012-02 |
|  | | Round | Flat | blue green orange red white yellow | 50-001-11 50-001-12 50-001-13 50-001-14 50-001-15 50-001-16 |
|  | | Rectangular | Flat | blue green orange red white yellow | 50-002-11 50-002-12 50-002-13 50-002-14 50-002-15 50-002-16 |
|  | | Square | Flat | blue green orange red white yellow | 50-003-11 50-003-12 50-003-13 50-003-14 50-003-15 50-003-16 |

TACT SWITCHES

NAVIGATION SWITCHES

PUSHBUTTON SWITCHES

TOGGLE SWITCHES

ROCKER SWITCHES

SLIDE SWITCHES

SNAP-ACTION SWITCHES

DIP SWITCHES

KEYLOCK SWITCHES

ROTARY SWITCHES

DETECTOR SWITCHES

CAP OPTIONS

SERIES D16, P16, L16 SWITCHES

PUSHBUTTON SWITCHES - ILLUMINATED

TACT SWITCHES

NAVIGATION SWITCHES

PUSHBUTTON SWITCHES

TOGGLE SWITCHES

ROCKER SWITCHES

SLIDE SWITCHES

SNAP-ACTION SWITCHES









DIP SWITCHES

KEYLOCK SWITCHES

ROTARY SWITCHES

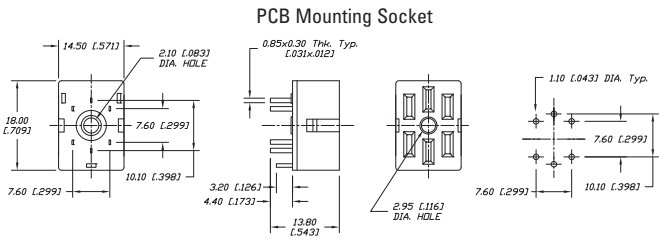
DETECTOR SWITCHES

CAP OPTIONS

| ILLUSTRATION | CATEGORY | DESCRIPTION | PART NO. |
|---|---|---|--|
|  | Lamp Extractor * Also available for LA Series | Lamp removing tool | 50-005-01 |
|  | Blanking Plate Block | PVC stopper to stuff the superfluous hole of the panel board | 50-013-01 |
|  | Connector * Also available for LA Series | Insulation Socket 2.8 x 0.5 mm | 50-014-01 |
|  | PCB Mounting Socket |  | 50-015-01 |
|  | Mounting Wrench * Also available for LA Series | Use this for tightening the switch in the mounting hole | 50-006-01 |
|  | Lens Removing Tool | Use this for replacing the fitted color lens | 50-007-01 |
|  | Spray Cover | Meets requirement of IP65, two pieces of transparent plastic, rectangular head | 50-010-01 |
|  | Protection Cap | To avoid faulty operation, housing for locking, transparent For square head (90°) For square head (180°) For rectangular head (90°) For rectangular head (180°) | 50-011-01 50-011-11 50-011-02 50-011-12 |